

MANUAL PARA LA OBSERVACIÓN PLUVIOMÉTRICA

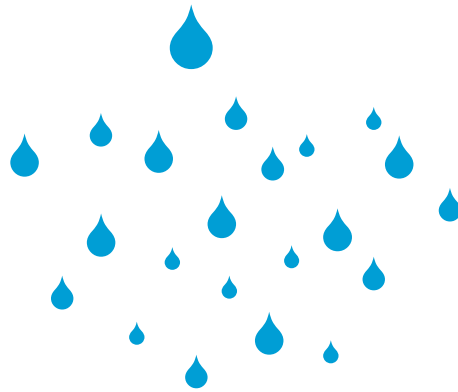

FORSAT

MANUAL FOR RAINFALL OBSERVATION



AUTHORS

Group of authors from the National
Institute of Hydraulic Resources

UNDP COORDINATING WORKGROUP

Eng. Liliana Pino Carballido
Arch. Rosendo Mesías González
B. Maydelis Gómez Samón
B. Elvilayne Vidal Medina
B. Dayana Kindelán Peñalver
MSc. Inalvis Rodríguez Reyes

EDITION

Lilian Sabina Roque

GRAPHIC DESIGN

Geordany G. O'Connor

2017

The points of view expressed in this
publication do not necessarily reflect the
views of the European Union, the United
Nations or the United Nations
Development Programme (UNDP).



Background of the first
rainfall measurements
in the world



Cuba and its climatic
resources



Hydrologic observation



FORSAT Project in
hydrologic observation

Background of the first rainfall measurements in the world

5

The first known references to the measurement of rainfall can be found in the book *Artha-shastra*, in India, in the fourth century before Christ. This book states the placement of containers of a specific measure in front of farmhouses which were used as species of pluviometers; in this way the amounts of regular rainfall in different locations was recorded and, according to the quantity measured, they decided which seeds to plant according to amount of water required.

In the *Mishnah*, a book about Jewish life in Palestine from the second century BC up to the second century of the modern era, there is a second reference to the measurement of precipitation, also for agricultural purposes. A rainfall of 540 millimeters was reported, although it is not specified whether it corresponds to a single year or the average of several, nor where the measurement was exactly made.

But neither the measurements in Palestine nor those in India continued for so long. They were isolated events. It was not until almost a thousand years later that the rain measurements were again reported. In China, around 1247 ac, precipitation measurements were described in the *Shushu Jiuzhang* mathematical treatise. In addition to the installation of rain gauges in the capitals of provinces and districts, the calculation of regional averages based on specific measurements is described. Although later, the constant floods of the rivers in China were supposed as the cause of the necessary use of rain gauges, the real reason was that the motive was again agricultural.

In 1441 in Korea, during the reign of King Sejong of Lee Dynasty, the first bronze and standard opening rain gauge, called *Cheugugi*, was introduced. This was distributed in all the provinces and cantons of the country, possibly for rice cultivation purposes. It was used continuously and unchanged until 1907.

In 1639, Benedetto Castelli, a disciple of Galileo, carried out the first measurements of rainfall in Europe, to know the contribution of water from a rain event to Trasimeno Lake.

In 1663 the British Christopher Wren and Robert Hooke developed a device known as "wise of the time" that was powered by a counterweight watch. This device registered barometric pressure, temperature, rain, relative humidity and wind direction every 15 minutes in the form of perforations made on paper tapes. The rain was measured by tipping bucket, and was a simple bucket, unlike its modern versions that are double buckets.

The first continuous record of the rain was made by Richard Towneley, in Lancashire, England, from 1677 to 1703. The meter included a 30 centimeters diameter funnel placed

MANUAL FOR RAINFALL OBSERVATION

6

MANUAL FOR RAINFALL OBSERVATION

on the roof of his house and connected to a tube towards the inside of this. The water was measured through a graduated cylinder.

The interest in the measurement of rain grew rapidly from the 18th century. Rain gauges are perfected, but the basic principles remain the same. Nowadays we have a great variety of equipment, generally classified as: manual or non-recording, of which more than 50 different models in the world are estimated to exist; mechanical recorders, with operation by flotation or by weighing; electrical recorders, with tilting trough systems, electronic weighing, capacitance, drop counting, among others.

Rain gauge: Instrument to measure the height of precipitation water at a point.¹

Totalizer rain gauge: Rain gauge whose data is controlled after ample time intervals.²

Precipitation:³

1. Liquid or solid elements from the condensation or sublimation of water vapor that fall from the clouds or are deposited from the air in the ground.

2. Amount of precipitation falling on a unit of horizontal surface per unit of time.

¹ UNESCO/OMM Hydrology International Glossary, 3rd edition, revised on 2012.

² Ídem.

³ Ídem.

Cuba and its climatic resources



The Cuban archipelago is located in the Caribbean Sea. Its main island is the largest of the West Indies. Isla de la Juventud and a multitude of keys or small islands surrounding the aforementioned major are also part of the archipelago, among which are: Cayo Coco, Cayo Guillermo, Cayo Largo del Sur, Cayo Jutía, among others. To the north are the United States and the Bahamas, to the west Mexico, to the south Cayman Islands and Jamaica and to the southeast Hispaniola island, shared by the Dominican and Haiti Republics. The surface area of the Cuban archipelago is 109 884.01 km².

According to the political-administrative division established on 2011, the territory is distributed in 15 provinces and 168 municipalities, including the special municipality Isla de la Juventud. The population by the ends of 2014 was 11 238 317 inhabitants.

The plains predominate in 75% of the territory, followed by 21% of low altitudes and mountains. The remaining 4% of the territory is formed by wetlands. The configuration of the country, in an elongated and narrow way, together with the layout and structure of the relief surface, determine the existence of a central watershed along the main island, in the direction of its longitudinal axis, which defines two main slopes: the northern slope and the southern one.

As a consequence of this particular characteristic of our territory, almost all of the Cuban rivers flow in the opposite direction of the central watershed. There are 272 basins that drain to the north, in the Gulf of Mexico and in the Atlantic Ocean; while other 327 do it to the south, to the Caribbean Sea.

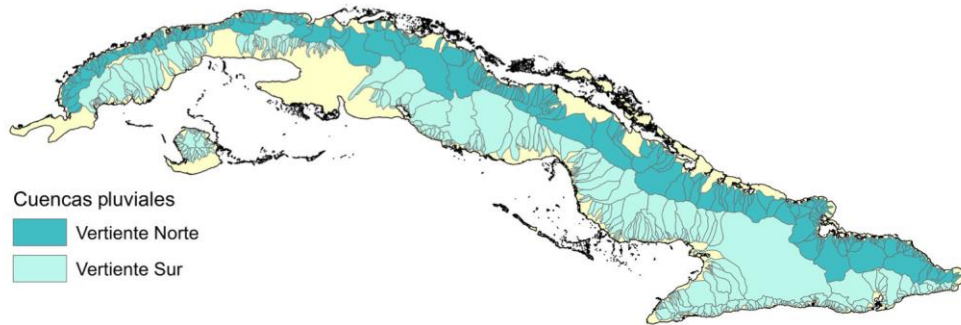
MAP 1. RAINFALL BASINS

The Cuban climate is tropical, humid by seasons, with a big sea influence and features of semi-continently. Temperatures vary from 24 to 26 Celsius degrees. Relative humidity is predominantly high, with values over 60 %. Potential evaporation is high, with an average of 1600 mm.

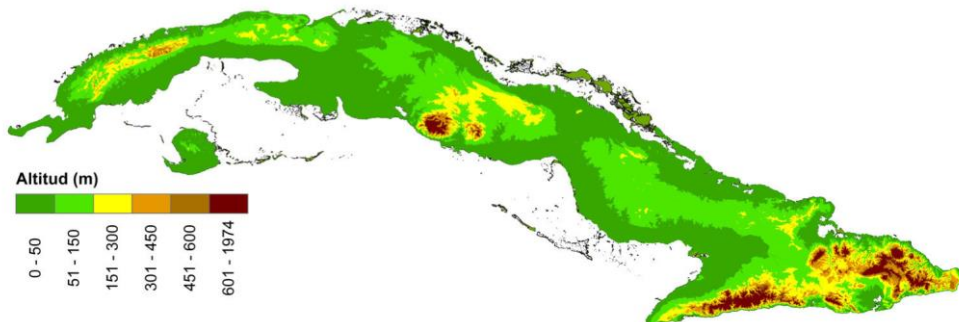
MAP 2. RELIEF

SPACE AND TEMPORARY CHARACTERISTICS OF PRECIPITATION IN CUBA

Precipitation is the element of greatest variability, both spatially and temporally, in Cuba's climate and the main source of its renewable water resources. The annual average of national precipitation, current since 2000 and representative of 1961-2000 period, is 1335 mm.

In average dry years, this value drops to 1180 mm; while, in average wet years it rises to around 1450 mm. In most of the territory, two fundamental seasons are recognized: rainy, from May to October, in which about 75% of the total annual rainfall falls; and not very rainy, from November to April. However, in the northeast of the eastern region, the percentages of annual rainfall observed in the aforementioned periods change significantly and can even be slightly inverted.

In particular, different regions of Cuba are defined with unequal rainfall conditions, both in their annual and inter-annual behavior. In a year of normal rainfall, 1437 mm precipitate in the western region of the country, 1308 mm in the central region and 1279 mm in the eastern region.

The eastern region is the one that presents the greatest contrasts, since it contains the places of greatest and least rainfall in Cuba. So we have that the rainiest place is El Toldo peak in Moa (Holguín), where 4400 mm fall every year. However, scarcely 40 km away to the south, in San Antonio del Sur (Guantánamo), annual rainfall barely rises to 400 mm.



MAP 3. PRECIPITATION

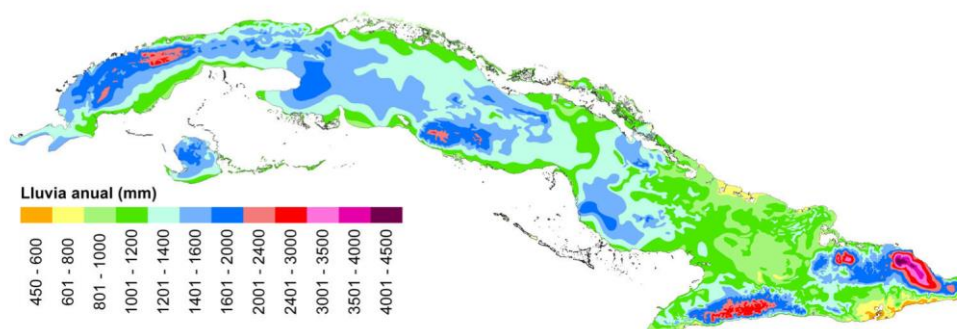

In the mountains of Turquino peak, in eastern Cuba (which rises to almost 2000 m above sea level), precipitations rise up to 2600 mm; in San Juan peak, in the heights of Trinidad, in the central part of the country (with around 700 m less height) almost the same amount of rain falls, 2400 mm. On the other hand, in Pan de Guajaibón mountain (with a height of less than 800 m), rainfall reaches up to 2,800 mm per year. In most flat and undulating regions the annual rainfall is close to 1400 and 1600 mm.

Another feature of the spatial distribution is the increase in rainfall in relation to the distance from the coast. The annual average in the coasts, can generally vary between 1000 and 1200 mm.

One element of particular influence on the hydrological regime of Cuba is the presence of tropical storms with remarkable rainfall intensity, which are formed in the Caribbean area between June to November. Studies carried out on the hydrological characteristics of the torrential rains have made it possible to specify the significant role that these play in the hydrological regime of some localities in which, sometimes, these rains can exceed the average for one year.

TABLE 1. INTER-ANNUAL DISTRIBUTION OF AVERAGE RECORDED RAINFALL.

PROVINCE	JANUARY	FEBRUARY	MARCH	APRIL	MAY	JUNE
Pinar del Río	56,4	50,1	59,1	72,3	157,6	224,4
Artemisa	68,6	53,9	61,6	77,1	148,2	214,2
La Habana	70,4	60,2	59,1	62,5	112,0	207,9
Mayabeque	52,6	44,8	54,9	61,0	149,7	253,8
Isla de la Juventud	60,6	43,8	42,2	51,8	148,5	224,9
Matanzas	41,7	38,8	53,9	64,9	164,9	237,6
Villa Clara	40,4	35,3	57,3	75,3	159,1	203,0
Cienfuegos	44,9	36,8	59,0	69,2	173,9	246,6
Sancti Spíritus	39,3	35,7	52,0	65,2	176,2	226,6
Ciego de Ávila	32,2	28,8	52,4	53,6	165,4	191,2
Camagüey	36,3	36,2	55,2	64,8	192,6	199,6
Las Tunas	30,3	27,3	51,3	58,9	145,7	157,0
Holguín	67,2	57,3	67,9	80,6	161,7	142,7
Granma	37,3	40,5	58,4	85,3	172,0	168,0
Santiago de Cuba	41,7	44,0	75,0	94,1	207,1	154,9
Guantánamo	81,4	74,9	87,3	102,4	209,0	122,7
Cuba	46,80	42,60	59,30	72,10	170,60	194,80

JULY	AUGUST	SEPTEMBER	OCTOBER	NOVEMBER	DECEMBER	TOTAL
165,0	193,6	240,4	148,3	69,6	43,9	1480,7
164,3	188,4	224,0	143,8	80,7	48,6	1473,4
141,3	158,4	197,7	141,5	70,1	47,9	1329,0
173,1	191,9	216,8	130,7	52,0	37,3	1418,6
161,5	193,7	235,0	154,2	57,3	51,5	1425,0
177,2	199,2	223,1	134,5	42,5	29,7	1408,0
143,6	152,0	179,7	153,7	63,7	31,9	1295,0
177,0	203,8	218,4	147,7	54,9	24,8	1457,0
160,1	194,2	211,3	165,7	62,5	25,2	1414,0
117,2	143,6	163,4	149,9	61,7	29,6	1189,0
120,2	158,4	173,7	152,5	67,7	25,8	1283,0
95,1	125,0	140,3	131,4	54,6	21,1	1038,0
80,5	106,0	137,5	165,2	119,6	66,8	1253,0
131,2	156,0	165,8	166,4	76,3	30,8	1288,0
110,2	138,3	173,7	178,0	93,0	43,0	1353,0
88,0	119,5	153,8	187,7	163,9	97,4	1488,0
134,10	161,10	186,20	153,80	74,60	39,00	1335,0

WATER RESOURCES

The potential water resources of the Cuban archipelago are evaluated, for more than a decade, in a total of 38 138 hm³ per year. Of these, 6456 hm³ are underground, distributed in 165 hydrogeological units, and the remaining 31 682 are surface ones, distributed in 642 hydrographic basins. However, the results of the rain study for the preparation of the current Precipitation Map of Cuba 1961-2000 (INRH, 2005) show that these potential resources are probably lower.

The usable water resources are evaluated at around 23 888 hm³ per year, corresponding 17 894 hm³ (75%) to surface water and 5994 hm³ (25%) to groundwater.

GRAPH 1. USABLE WATER RESOURCES 24 km³

■ Aguas Subterráneas ■ Aguas Superficiales

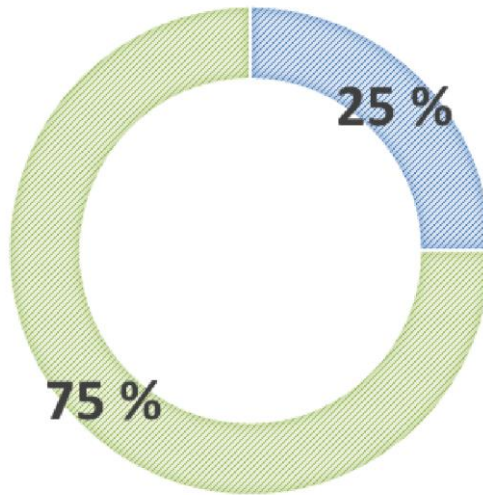

HYDRAULIC RESOURCES

With the hydraulic development achieved, mainly between the years 1960 and 2000, in which the reservoir capacity has increased around 200 times, the hydraulic resources available to the economic, social and environmental demands of the country rise to 13,728 hm³ per year (9233 surface hm³ and 4495 hm³ underground), equivalent to 57% of usable resources.

13

HYDRAULIC INFRASTRUCTURE

Exploitation

242 reservoirs with a total capacity exceeding 9000 hm³ that guarantee an annual delivery of more than 7000 hm³

729 micro-reservoirs that store more than 500 million m³, delivering approximately 400 hm³ per year

61 diverters

20 large pumping stations for water transfers

2317.6 km of protection constructions, between protection dams or embankments and channels

806.08 km of master channels

180 hydro-electric facilities with an installed capacity higher than 65 mW.

MAP 4. RESERVOIRS

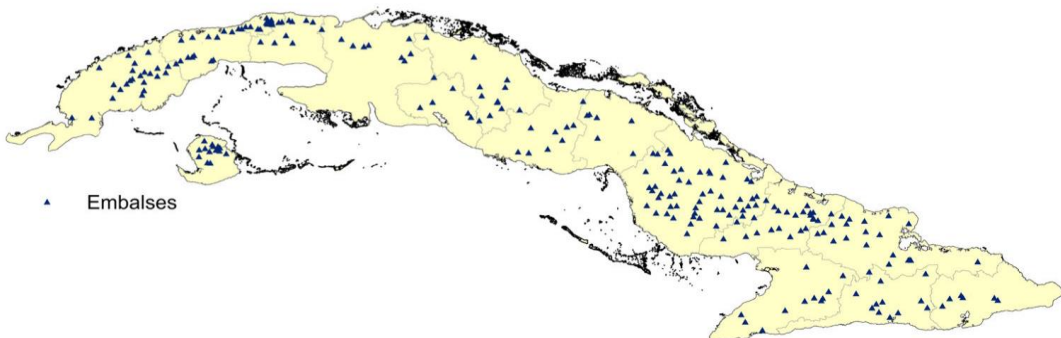



ZAZA RESERVOIR AND ZAZA-SUR DEL JÍBARO MASTER CHANNEL.



MOA DIVERTER, HOLGUÍN.



GUISA DAM, ALLEVIATE.

Water supply

2480 aqueducts

2815 pumping stations

23 318,32 km of pipes in networks and conductors

5 desalination plants

79 water treatment plants

2268 chlorination stations

GRAPH 2. COVERAGE OF WATER SUPPLY TO THE POPULATION (95%)

■ Fácil acceso ■ Sin cobertura ■ Servicio público ■ Conexión domiciliar

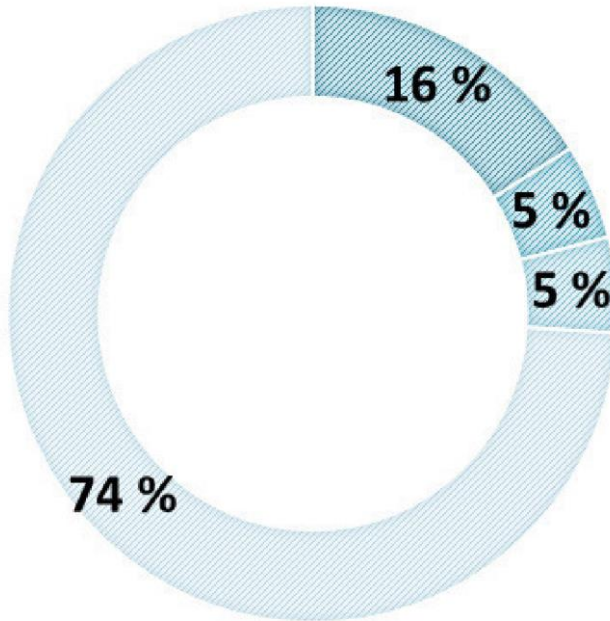

Sanitation

Nowadays around 515.2 hm³ of solid waste are evacuated, of which approximately 47% are treated, for which we have:

- 5292.3 km of sewer pipes
- 162 waste pumping stations
- 12 waste treatment plants
- 304 oxidation ponds
- 878 138 sewage pits
- 483 septic tanks

GRAPH 3. SANITATION COVERAGE (97 %)

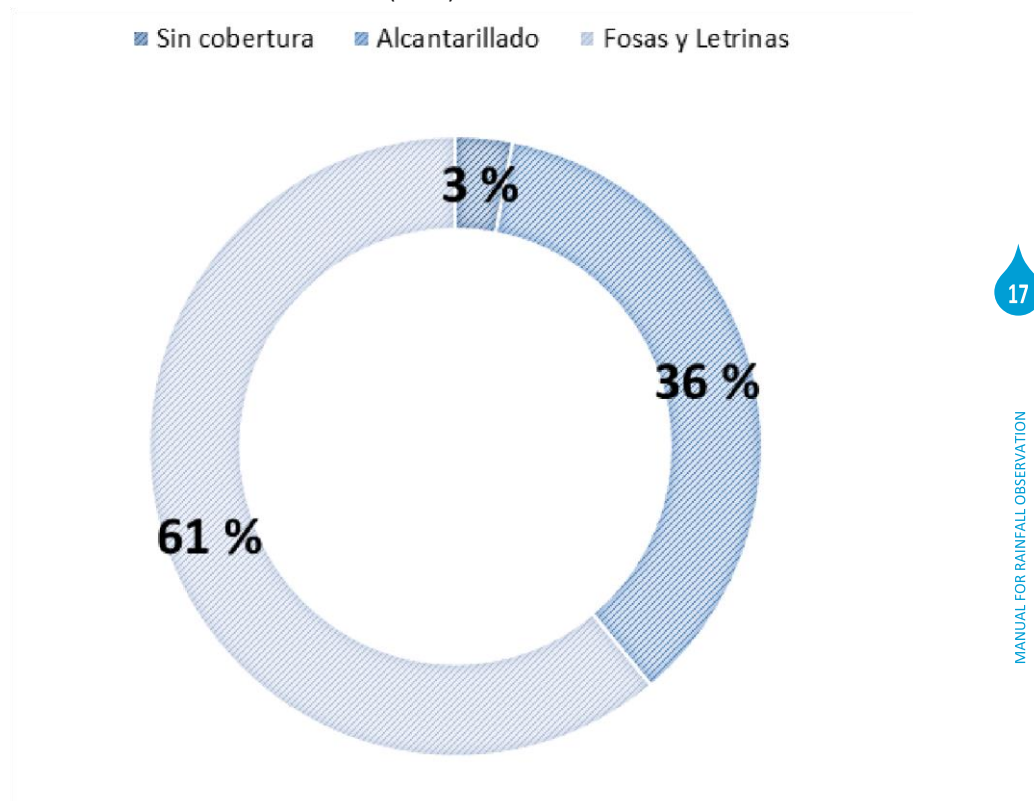

WATER USE

Apart from the hydraulic development achieved by the country, the Cuban archipelago is characterized by limited renewable water resources. According to its usable water resources, by the ends of 2015, the classic availability rate was limited to 2130 m³ per inhabitant / year for all uses; considering hydraulic resources, the index is reduced to 1220 m³.

Of the current availability, there is a plan to use around 7000 million m³ every year (approximately 51%). In 2015, 7,685.7 million cubic meters of water were used for all purposes, of which 68% came from surface sources and 32% from underground sources. The agricultural sector and other uses, among which are the ecological requirements (environmental flows), used 5707.7 million (74%); the supply to the population used 1603.8 million (21%); and the industrial sector not linked to the aqueduct system, 374.2 million (5%). The distribution and use of water in Cuba correspond to that of a country that is essentially dependent on agricultural activity.

GRAPH 4. WATER USE IN CUBA

- Pastos y forrajes
- Cítricos y frutales
- Caña
- Viandas y hortalizas
- Otros consumos
- Arroz
- Industria y Población

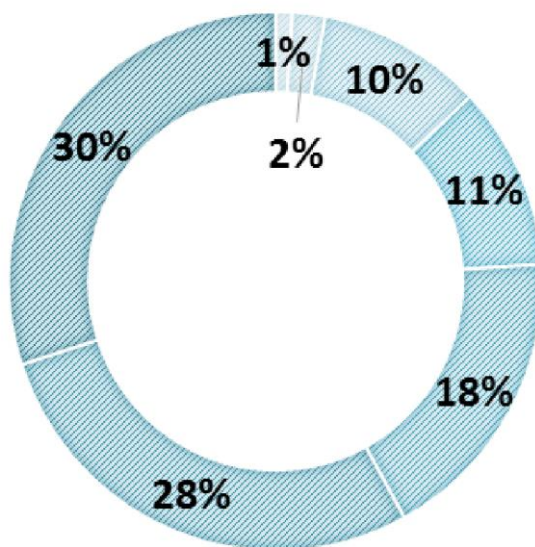

Hydrologic observation

Observation or monitoring of the hydrological cycle, the reliable and systematic assessment of water availability and its short- and long-term perspective are elements of vital importance for the country's water development and water management, whether in conditions of scarcity or abundance.

Hydrological observation is materialized through hydrological networks, at whose points or observation stations the necessary data are gathered to evaluate and characterize the different stages of the hydrological cycle.

Hydrological networks allow the evaluation of the surface quantity and quality and underground water and hydraulic resources. For quantification purposes, these networks are divided, according to the variables or elements observed, into: rainfall, pluviographic, climate and hydrometer, for surface water; and the observation of groundwater levels.

On the other hand, for the qualitative evaluation, in addition to the hydrogeological networks of physical-chemical sampling and vertical hydro-chemical sounding or bastometry, the water quality network (REDCAL) has a series of specific functions that constitute a fundamental link within the activity of pollution control and monitoring, whether caused by overexploitation of the resource or by direct or indirect disposal of wastes to terrestrial waters.

To measure the water quantity and quality in Cuba, hydrological networks are currently composed of:

1998 rainfall stations

12 hydro-meteorological stations

38 hydrometric stations

1706 observation wells for groundwater

3661 stations of the water quality network (REDCAL), of which 2865 are basic stations and 796 monitoring ones.

The stable operation of hydrological networks and the consequent hydrological observation in our country involve, with a broad sense of organization, regularity and discipline, to almost the whole system of the National Institute of Hydraulic Resources (INRH) and more than a thousand women and men who voluntarily monitor rain.

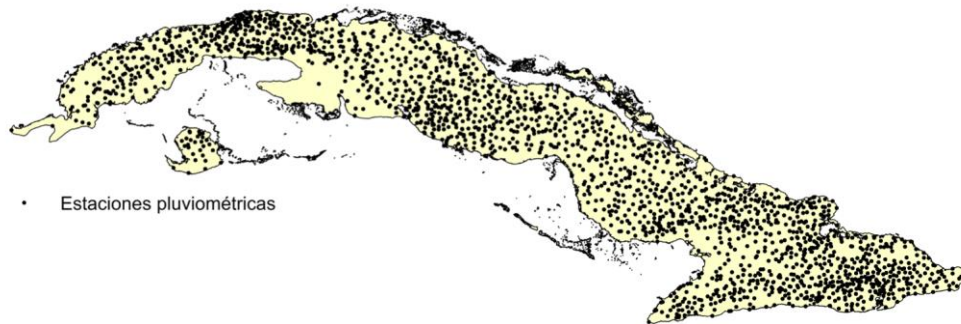
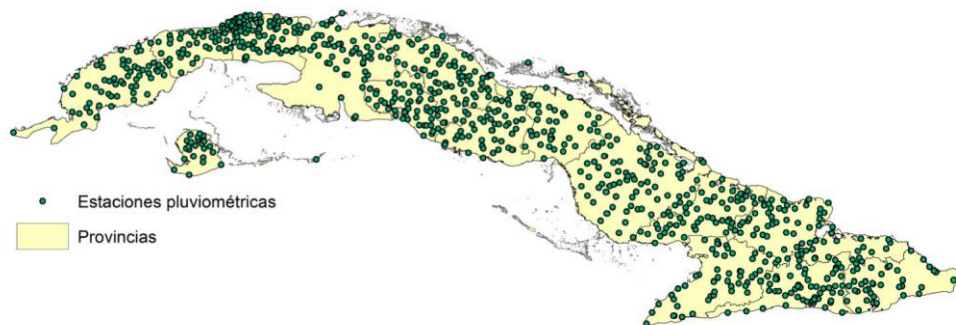
MAP 4. TOTAL RAINFALL NETWORK**MAP 5. DAILY SPECIAL INFORMATION NETWORK**

USES OF HYDROLOGICAL INFORMATION

The main mission of a hydrological service or an equivalent agency is to provide information to decision-makers about the state and evolution of the country's water resources. Such information may be necessary for:

- a) The evaluation of the country water resources (quantity, quality, temporal and spatial distribution), the potential for the development of this resource and the capacity to satisfy the current and future demand.
- b) The planning, design and execution of water projects.
- c) The evaluation of the environmental, economic and social effects of the current or planned management practices of water resources, as well as the adoption of proper policies and strategies.
- d) The evaluation of the water resources repercussions on the activities of other sectors, such as urbanization or forestry exploitation.

e) The security of people and goods against the risks related to water, particularly floods and droughts.

In general, a hydrological service provides the necessary information for the evaluation of water resources, which is defined as the determination of the sources, extent, reliability and quality of water resources, on which an assessment of the possibilities is based in terms of use and control.

Thanks to the growing concern about issues such as global climate change and the impact of urban development on the environment, emphasis is placed on the demand for reliable hydrological information that serves to establish sustainable development and management of water resources. This implies that future generations will continue to enjoy proper and affordable water supply so that they can meet social, environmental and economic needs.

A REVOLUTIONARY AND HYDRAULIC WILL

There are many people who are responsible for monitoring and reporting the occurrence of precipitation along Cuba. Considered the primary link in Cuban water issues, rainfall observers are anonymous people and are very dedicated to the task of measuring rain levels daily, as well as issuing written reports of any kind of meteorological incident that may occur at their point of observation, with a view to a better evaluation and use of the country's water resources.

A particular case is the volunteer observers, people who take care of the rain gauge and measure the rain every day without receiving any remuneration. At present, of the total stations of the rainfall network, 1,198 are operated by volunteer observers, of them 529 women and 669 men. The age ranges between 17 and 100 years: 0.6% of them are younger than 25 years; 37.8% between 26 and 50 years old; 49.4% between 51 and 75 years; and 12.2% older than 75 years. There are no significant differences between the age of women and men who voluntarily observe rain.

TABLE 2. AMOUNT OF VOLUNTEER RAINFALL OBSERVERS BY PROVINCES

PROVINCE	TOTAL	WOMEN	MEN
Pinar del Río	63	29	34
Artemisa	40	14	26
La Habana	12	7	5
Mayabeque	70	35	35
Matanzas	84	41	43
Villa Clara	89	53	36
Cienfuegos	64	35	29
Sancti Spíritus	83	37	46
Ciego de Ávila	62	30	32
Camagüey	132	60	72
Las Tunas	74	23	51
Holguín	158	68	90
Granma	77	22	55
Santiago de Cuba	84	40	44
Guantánamo	91	31	60
Isla de la Juventud	15	4	11
Cuba	1198	529	669

Thanks to this work, the country has first-hand information to prepare newsletters and special reports to different media and socioeconomic objectives of the nation and the State. This information, provided by observers and rainfall observers, helps to understand the behavior studies on drought events. It is important to collaborate in the hurricane season, since precipitation levels must be spread quickly, from them depends decision making in a specific region.



MAP 6. RAINFALL STATIONS WITH VOLUNTEER RAINFALL OBSERVERS

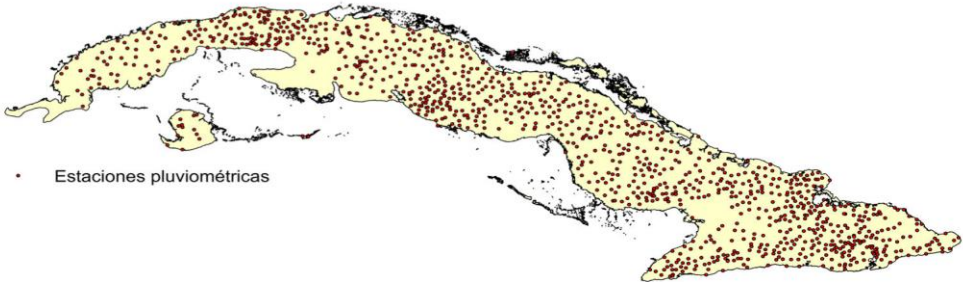

GROUP THAT PARTICIPATED IN THE XIV NATIONAL WORKSHOP OF VOLUNTEER RAIN OBSERVERS CARRIED OUT FROM APRIL 11 TO 15, 2016 IN SANCTI SPÍRITUS, IN THE FRAME OF FORSAT PROJECT, WHICH SUPPORTS THE EUROPEAN UNION AND THE UNITED NATIONS DEVELOPMENT PROGRAM (UNDP).

MEASUREMENT OF RAINFALL

For the manual measurement of rain in Cuba, the standard rain gauge from the National Weather Service of the United States of America (NWS), known as D-8, is used, which refers to the eight inches measured by its diameter.

Description of the standard rain gauge D-8.

Composed of five parts:

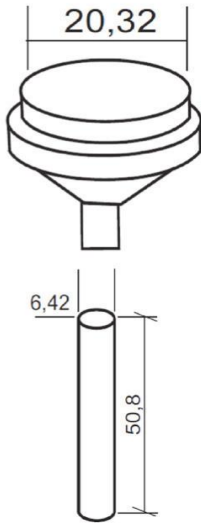

a) Funnel with beveled edges measuring 20.32 cm in diameter, which receives the precipitation.

b) Collecting cylinder or test tube of 6.42 cm in diameter and 50.8 cm in height, for accumulating water that falls into the funnel.

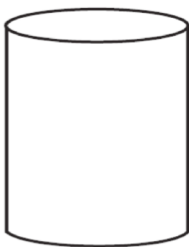

c) Cylindrical tank that serves as a support for the funnel and as a protector for the test tube. It is the one that also receives the surplus of rain when the test tube overflows. This tank, at the same time, has the function of preventing the direct action of the sun's rays on the test tube, reducing the possible losses by evaporation.

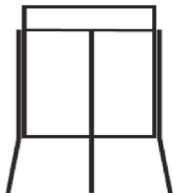

d) Iron tripod that serves to support the previous parts.

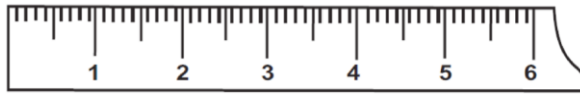

- e) Graduated scale ruler to give readings in millimeters, appreciating up to the tenth of a millimeter.

The relationship between the respective areas of the funnel and the test tube is ten to one. That is, in equal volume, the test tube, as its area is ten times smaller than the funnel, makes the water sheet to grow ten times in height; for this reason, it is classified as a multiplier rain gauge.

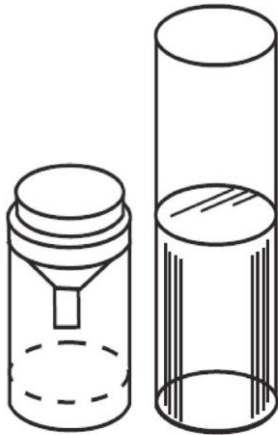

The test tube is tall and narrow, ten times smaller in area than the funnel. See the heights of the water sheets in both illustrative examples.

Regulations for installing the rain gauge

The rain gauge should be installed in an as clear as possible place. In this way the rain will come freely to the funnel. For this, any kinds of obstacles must be avoided: trees, houses, hills, towers, drafts, fences, etc.

The top of the funnel of a rain gauge should be at a height of 1.20 m above the ground. For the location of the rain gauge, the difference in height between the mouth of the funnel and the surrounding obstacles is measured. Then, the rain gauge must be at least four times the distance from the measured height of the nearest obstacle.

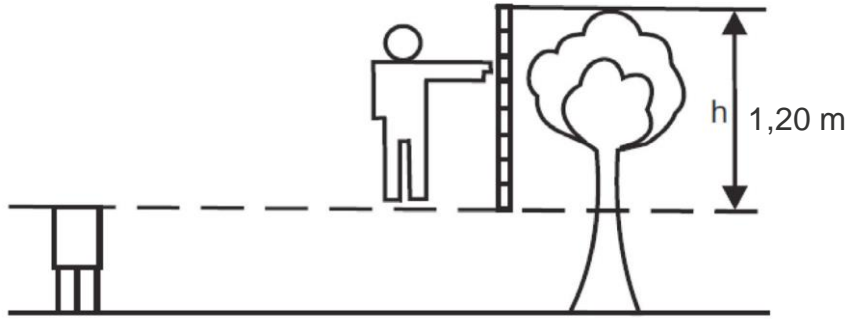

So, the rain gauge should be placed for times away of the height (h) of the tree measured.

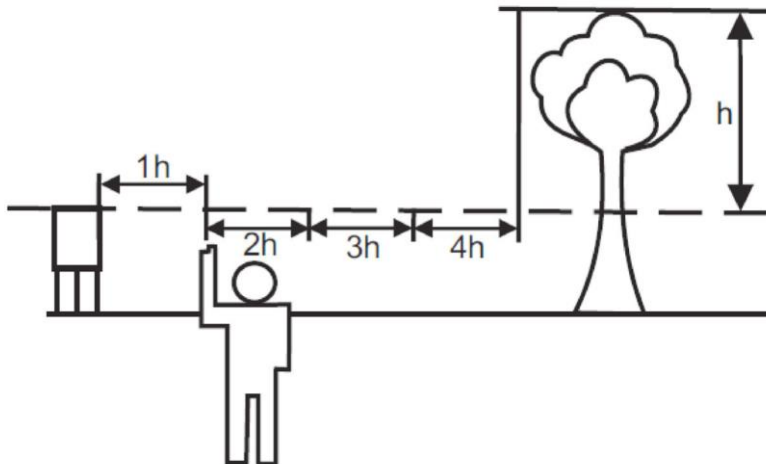

What do rainfall readings show?



Rain fall readings show the amount in height of precipitation sheet.



For example:

When the rain gauge has received an amount of water equivalent to 8 mm, it means that the rain fall would cover the surface of the ground with a sheet of 8 mm, if the soil did not undergo the infiltration, evaporation or runoff processes.

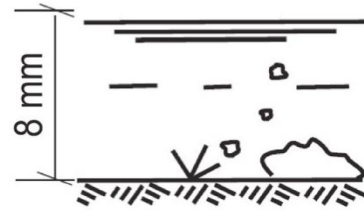

The essential thing about a rain gauge is that it has a flat, horizontal, fixed surface, perfectly determined and known which collects the precipitation that occurred in a given period and retains it completely without having evaporation or leaks, so that it can be measured with precision.

How to do the observation:



a) In normal conditions, a single daily observation will be made at 8:00 am (0800 hours).

b) In exceptional situations of intense rains and hurricanes, in rainfall stations specially selected for monitoring these events, several observations will be made on the day when a phase of work has been decreed by the Civil Defense Staff. That is, an observation will be made every eight hours, in the information phase; every four hours, in the alert phase; every two hours, in alarm phase; and in such a way that the observation is always made at 0800 hours.



c) At the time of observation, insert the dry ruler vertically, without touching the edges, through the hollow of the funnel until it touches the bottom.



d) Leave the ruler for one or two seconds and then carefully remove it.

e) Read the wet strip marked in the ruler and write down the numbering corresponding to the mark

Example: Let's suppose that the wet strip marks the intermediate division between 2 and 3. In this case the rainfall is 2.5 mm. If the wet strip does not coincide with some of the appreciation lines of the ruler, then the nearest line is taken as a reading.

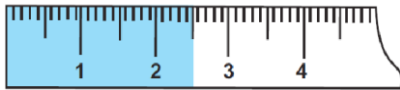

f) Remove the funnel and put it on its side on the floor, take care of its edges so that it does not deform.



g) Take out the inner cylinder or test tube and remove the water it contains, which has already been measured.



h) If there is water in the tank, you should measure it by pouring it carefully into the test tube and emptying it each time it is filled. Each filled test tube is equivalent to 50.8 mm more of rain. When you finish emptying the tank, if the test piece is not completely full, measure this water with the ruler, add and record it.

- i) If, when removing the funnel, the test tube is completely filled and there is no water in the tank, it should be checked for leaks. If so, it should be noted in the notebook and the report card: 50.8 / Plus leaks!

- j) Put the test tube and the funnel back into their positions.

Report and record of rainfall data

It is essential that each observer or rainfall observer make use of the book and card established to record and report the rain reading. Remember that the rain measurement must be done every day at the indicated time, no matter if it is raining or not, and record the readings on the date-corresponding observation made.

For the annotations the following steps will be followed:

- a) Every day, a single rainfall annotation corresponding to the rain accumulated in 24 hours, starting at 0800 hours of the previous day to 0800 hours of the day of measurement, will be made in the notebook. In exceptional situations of intense rains and hurricanes, and for the stations selected for monitoring these events, it is important to keep a separate record of the partial observations that allows to obtain the accumulated rainfall by the end of 24 hours without difficulty.
- b) If rainfall is detected when the measurement is made, the value observed in the ruler is recorded in the rainfall observation book on the sheet reserved for the current year and month and, within it, in the tables or rows destined to the corresponding day.
- c) In the two tables dedicated to the observation of rain every day, the number of millimeters will be written in the left column and the tenths of millimeters in the right column (For example: if you observe rainfall of 35,7 millimeters, 35 will be written down in the left column and 7 in the right column).
- d) If it did not rain, it is left blank.
- e) A line (-) should never be written because it means nothing to us.
- f) If it was not possible to perform the reading due to major causes, N.O. will be noted, which means no observation.

HOJA DE OBSERVACIONES

Mes

Año

DIA	LLUVIA		DIA	LLUVIA	
1	16	8	17		
2	29	0	18		
3			19		
4			20		
5	13	6	21		
6	35	7	22		
7	9	0	23	3	6
8			24	40	6
9	1	1	25	2	5
10	18	3	26		
11			27		
12	52	4	28		
13	21	6	29		
14			30		
15	73	2	31		
16	24	2			
			TOTAL MES	341	6

Número de días con lluvia.....	14
Máxima lluvia, día.....	15
Total del mes.....	341,6
Total anterior.....	698,3
Total del año hasta la fecha.....	1039,9

At the end of the month

At the end of the month the observer must record the monthly summary information in the rainfall observation book, for which it has the last row of the daily record table, as well as five other spaces located after it. The monthly summary is composed of:

- ✦ Number of days with rain (amount of days with observation higher than 0.0 mm)
- ✦ Maximum rain (day or days of the month with the highest value of rain). If there is a coincidence of days in the same month with the same reading values, so many days are recorded as corresponds to the same reading, separated by a comma.
- ✦ Total of the month (sum of all rainfall observations recorded during the month)
- ✦ Previous total (total of the year up to the date recorded in the sheet corresponding to the previous month)
- ✦ Total of the year to date (sum of the total of the month and the previous total)

Once the monthly summary has been made, the observer must write in the report card all the information from the book and take it as soon as possible to the nearest mail unit, in case the card is not collected directly in the rainfall station by INRH personnel.

Once at the provincial office of Hydraulic Resources

Once in the provincial unit, the data of the card is reviewed and recorded in the rainfall records as basic data, which are constantly consulted by technical and specialized personnel who are in charge of studying precipitation, its behavior and distribution in time and space, as a basic problem in hydrology, science that studies the water cycle in nature.

FORSAT Project in hydrologic observation

In order to protect about 39,000 inhabitants, their assets and economic resources located in areas vulnerable to flood risk due to heavy rains in the Zaza and Agabama river basins, FORSAT cooperation project is implemented by the United Nations Development Programme (UNDP) with funds from the Disaster Preparedness ECHO Programme (DIPECHO). This project allows to increase the effectiveness of the Hydro-meteorological Early Warning System (EWS) in the area of the basins mentioned in the provinces of Villa Clara and Sancti Spiritus.

The initiative improves the components of this EWS, which are:

1. The monitoring of heavy rains.
2. Appreciation of flood risk to make timely decisions aimed at protecting people and goods of the economy.
3. The issuance of the public notice to carry out such protection.
4. The development of an adequate preparation to give an effective response to these hydro-meteorological events.

Attention to gender equality is a topic to take into account throughout the project. Within component 1 (monitoring of heavy rains), special attention is paid to hydrological monitoring in the intervention areas of the project, in which rain observers and volunteer rain observers play an important role. FORSAT has allowed to have specialized equipment, including some of high performance, which complements the hydrological networks coverage of the National Institute of Hydraulic Resources (INRH) in these basins. With the acquisition, location and start-up of 26 automatic hydrological stations, 14 conventional stations and 14 radio-communication equipment with 2 communication repeater stations, a greater scope in hydrological monitoring is promoted.

This manual is an essential complement to improve hydrological monitoring, since it is aimed at guiding the work of the observers and the volunteer observers in charge of the equipment assigned to them, provided by FORSAT. It is also available for the remaining rainfall observers of these watersheds and throughout the country, in support of the successful experience that INRH has been developing for almost 55 years.

FORSAT also helps women and men involved in rainfall observation to improve their performance, have equal recognition, be trained, and visualize and pay attention to the gaps between them in life and their work relationships. We encourage you to consult and exchange on the contents of the recently published brochure: "Contributions of women and challenges of gender equality: Aspects to be taken into account in rainfall observation".



GLADYS MONTEAGUDO, VOLUNTEER RAIN OBSERVER IN SANCTI SPÍRITUS PROVINCE, SHARES HER EXPERIENCES DURING THE MONITORING VISIT OF THE EUROPEAN UNION AND UNDP (JUNE 2016, CHUCHO LOTTERÍA NEIGHBORHOOD).